

DIECI



APOLLO

26.6



dieci.com

PERFORMANCE

Vehicle model	APOLLO 26.6
Maximum capacity	2600 kg (5732 lb)
Maximum lifting height	5,68 m (18,6 ft)
Maximum horizontal extension	3,2 m (10,5 ft)
Fork swiveling angle	129°
Pull-out force	7600 daN (17085 lbf)
Towing force	4400 daN (9892 lbf)
Maximum climb angle	40%
Unladen weight	5000 kg (11023 lb)
Max speed (referred to wheels with maximum permitted diameter)	30 km/h (18,6 mph)

BOOM

Vehicle model	APOLLO 26.6
Lifting	7,8 s
Descent	4,1 s
Extension	6,1 s
Retraction	3,4 s
Forward swiveling	3,5 s
Reverse swiveling	2,2 s

ENGINE

Vehicle model	APOLLO 26.6
Brand	Kubota
Nominal power	55 kW (74 HP)
@rpm	2600 rpm
Operation	4-stroke
Injection	Electronic, Common rail
Number and arrangement of cylinders	4, Vertical in line
Displacement	3331 cm ³ (203 in ³)
Consumption	231 g/kWh (380 lb/Hp h)
@rpm	2600 rpm
Emission standard	Stage V/Tier 4f
Exhaust gas treatment	Catalyst + Particulate filter (DOC+DPF)
Cooling system	Liquid
Intake	Turbo compressor

DIFFERENTIAL AXLES

Vehicle model	APOLLO 26.6
Type of axles	2 steering, with 4 epicycloidal reduction gears
Type of steering	4 wheels / transversal / 2 wheels
Front axle	Rigid
Rear axle	Swinging
Service braking	Oil bath on front axle
Parking braking	Negative actuation with electrical control

HYDRAULIC SYSTEM

Vehicle model	APOLLO 26.6
Hydraulic pump type	Gear pump for power steering and movements
Hydraulic pump capacity	80 L/min (21,1 gal/min)
Max. operating pressure	23,0 MPa (3336 psi)
Distributor control	4 in 1 proportional Joystick

REFUELING

Vehicle model	APOLLO 26.6
Hydraulic system (total)	70,0 L (18,49 gal)
Fuel tank	80,0 L (21,13 gal)

TRANSMISSION

Vehicle model	APOLLO 26.6
Transmission type	Single speed Hydrostatic transmission with variable displacement pump
Hydraulic motor	Hydrostatic with continuous automatic adjustment
Reversal	Electro-Hydraulic
Inching	With hydraulic pedal for controlled forward movement

TIRES

Vehicle model	APOLLO 26.6
Standard tires	12x16.5"
Optional tires	15.0/55-17" - 12.0/75-18" - 280/80 R20"

DIMENSIONS

Vehicle model	APOLLO 26.6
A	270 mm (10,6 in)
B	985 mm (38,8 in)
C	2350 mm (92,5 in)
D	765 mm (30,1 in)
F	3535 mm (139,2 in)
G	4125 mm (162,4 in)
H	1950 mm (76,8 in)
I	1850 mm (72,8 in)
L	1500 mm (59,1 in)
M	1850 mm (72,8 in)
P	1460 mm (57,5 in)
Q	3555 mm (140 in)
S	1433 mm (56,4 in)
T	200 mm (7,9 in)

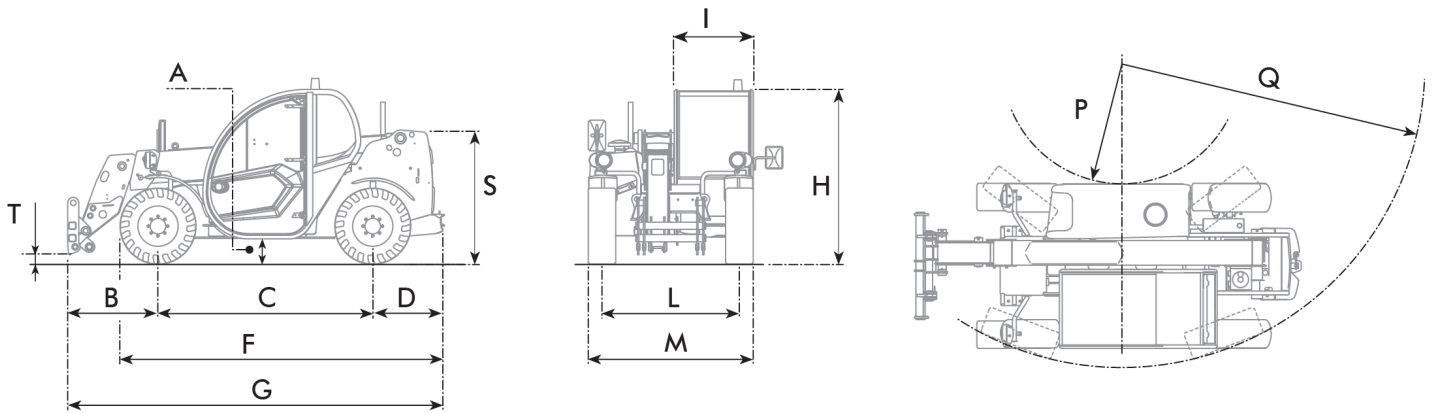

MAX
2600 kg / 5732 lb

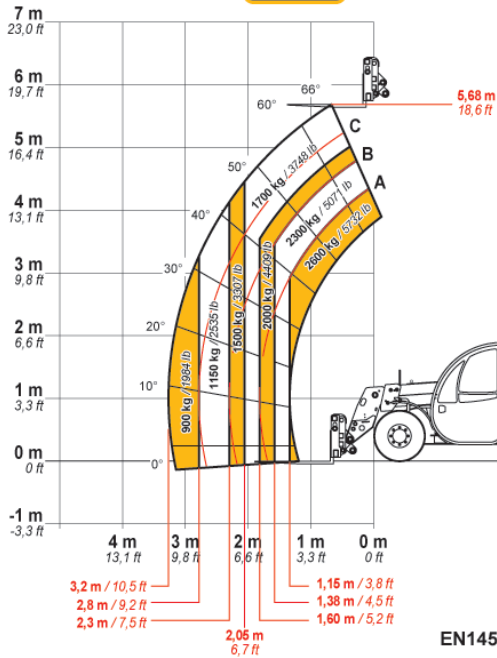

DOC10000822



26.6

EN1459 Annex-B



Dieci Srl - Via E. Majorana, 2-4 - 42027 - Montecchio Emilia (RE) ITALY

Tel. +39 0522 869611 - Fax +39 0522 869798 - E-mail: info@dieci.com - www.dieci.com

DOCCT0000010-EN-02